

Outdoor Dome Housing

Unit: [Inch]
mm

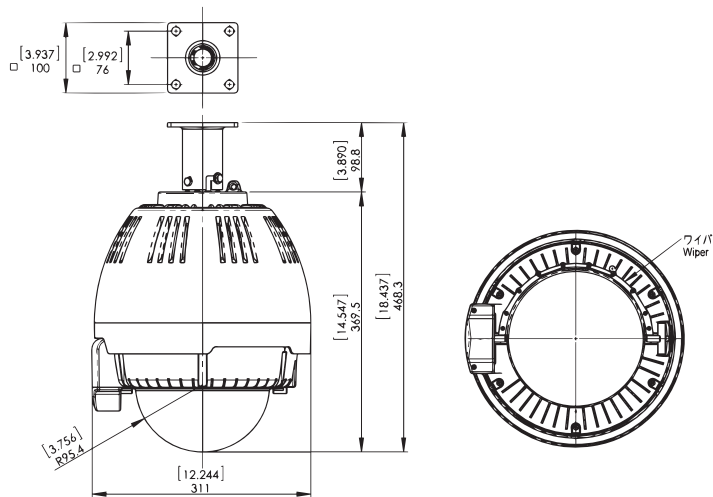

[Type B Ceiling Mount]

A-ODW7W **SB**

Capsule
C=Clear
T=Tinted

Housing Color
Nothing=Standard (Silver)
(OW)=Off-White
(DB)=Dark Brown

Blower Heater
2=Type 24VAC Blower and Heater Installed
12=Type 12VDC Blower, Heater installed
12(POE+)=Type 12VDC Blower, Heater and POE Splitter installed in housing*1,*2
12(POE+M)=Type 12VDC Blower, Heater and POE Splitter installed in housing and Midspan are packed in product box *1,*2

"Optional" Two-Coat system for Metal Parts(Bracket) for corrosion protection*3
Nothing = Standard One Coat by UV resistant polyester powder coat
-TC = "Optional" Two-Coat
-TTC= Optional Three Coat*4

6 Disits registered model name(UL&PSE) After 7 digits shows optional specifications

Specification	
Operating Environment	Outdoor
Operating Temperature	-50°C~+45°C (24VAC/12VDC 50W)
	-30°C~+45°C (POE 60W)
IP Rate	IP55 (Vent Holes "Open")
	IP66 (Vent Holes "Closed" with provided Rubber)
Max Wind Load	66m/sec
Materials	Housing = PC/ABS UL94 V-0 Housing Top = Aluminum
	Ceiling Mount Bracket = Steel Capsule = PC (Light Loss of Tinted Approx.70%)
Color	Standard Silver: Silver (Housing) Black (Housing Top & Bracket)
	Offwhite: RAL9002 Similar
	Darkbrown: Munsell 5YR2/1.5 Silimilar
Weight	Approx. 6.5kg (14.3lbs)
Recomended Screw	3/8" or M8~M10 Stainless Screw x 4 (Not included in product)
Power Consumption of Heater	2) Type 24VAC 25W (50W for Cold Area* Confirmation Necessary)
	12) Type 12VDC 6W, 12W, 25W, 50W (*Confirmation Necessary)
	POE) Type POE 6W or 25W (*Confirmation Necessary) *Before Ordering, obtain our confirmation for Camera and Midspan Power.
Blower & Heater	Blower 35°C(ON) 27°C(OFF) Auto or Continous by Jumper Connector
	Nidec 12VDC 0.5W Blower EUDC12D8 x 2pcs.=1W
(Optional)	Heater 4.4°C(ON) 16°C(OFF)Auto Only
Compliance	RoHs, PSE, CE, RCM, UL(File# E313815)

- *1 Due to size and specification of camera splitter may not be installed in housing.
- *2 As regards the specification of both Splitter and Midspan, you are requested to obtain our confirmation in advance before ordering.
- *3 Optional" Two-Coat system comprises 1 coat = powder coating primer (Epoxy base) and Top coat = UV resistant (Polyester base) powder coating based on our standard.
- *4 Before Two Coat(-TC), Cation Electrodeposition will be added.
(For details, click our website top "Anti-Corrosion Paint")